

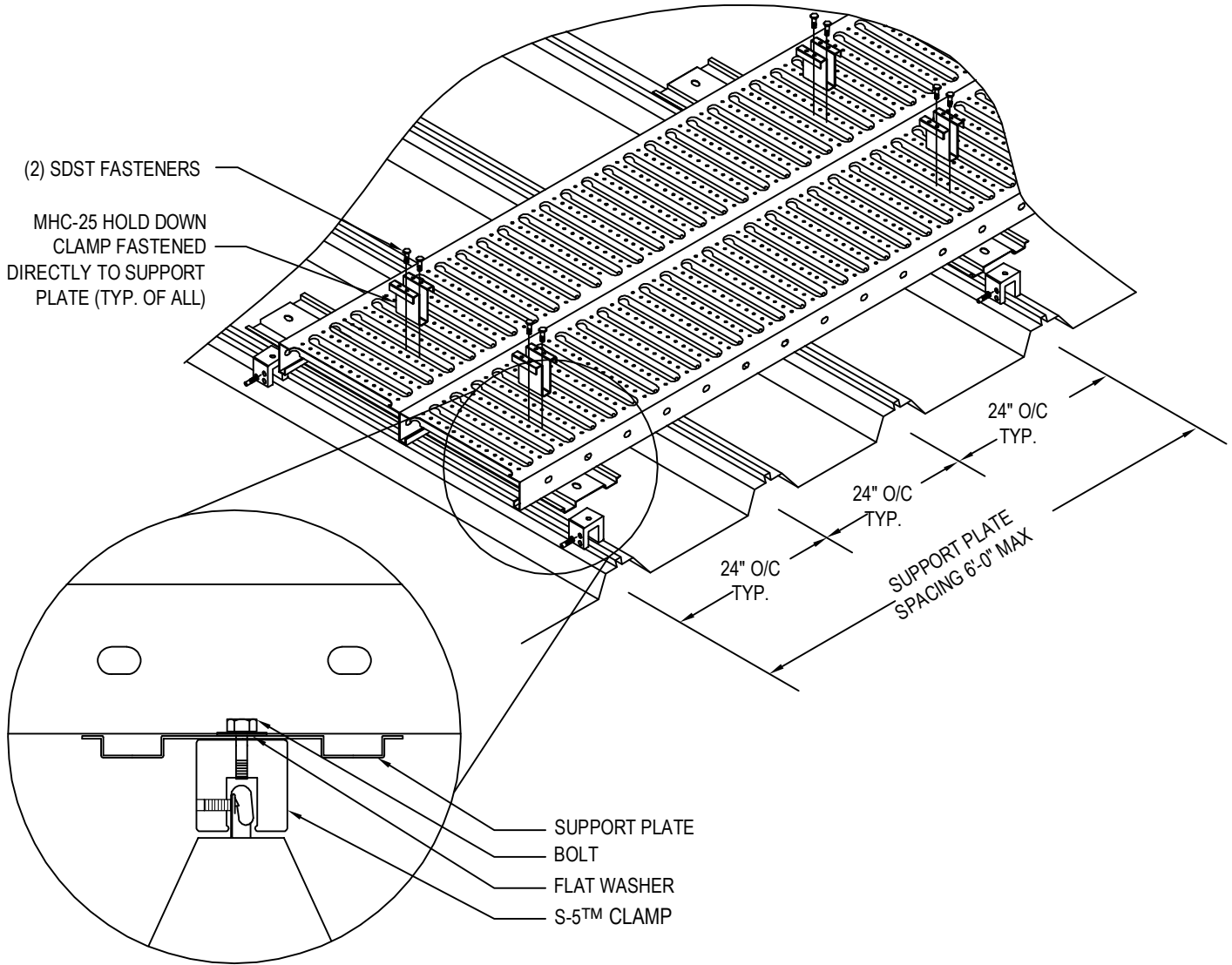

DESIGN COMPONENTS INC / METALWALK
 115 WALTER WAY
 FAYETTEVILLE, GA 30214
 PHONE: (800) 868-9910
 FAX: (770) 460-7872
 www.rooftopwalkway.com



NOTES:

1. INSTALLATION TO BE COMPLETED IN ACCORDANCE WITH MANUFACTURER'S SPECIFICATIONS.
2. DO NOT SCALE DRAWING.
3. THIS DRAWING IS INTENDED FOR USE BY ARCHITECTS, ENGINEERS, CONTRACTORS, CONSULTANTS AND DESIGN PROFESSIONALS FOR PLANNING PURPOSES ONLY. THIS DRAWING MAY NOT BE USED FOR CONSTRUCTION.
4. ALL INFORMATION CONTAINED HEREIN WAS CURRENT AT THE TIME OF DEVELOPMENT BUT MUST BE REVIEWED AND APPROVED BY THE PRODUCT MANUFACTURER TO BE CONSIDERED ACCURATE.
5. CONTRACTOR'S NOTE: FOR PRODUCT AND COMPANY INFORMATION VISIT www.CADdetails.com/info AND ENTER REFERENCE NUMBER 5018-014.

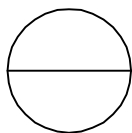

ROOFTOP METALWALK SYSTEM - TRAPEZOID SSR

24" WIDE METALWALK®, NO HANDRAIL, S-5™ CLAMP, PERPENDICULAR

