

UPBLAST ROOF FANS

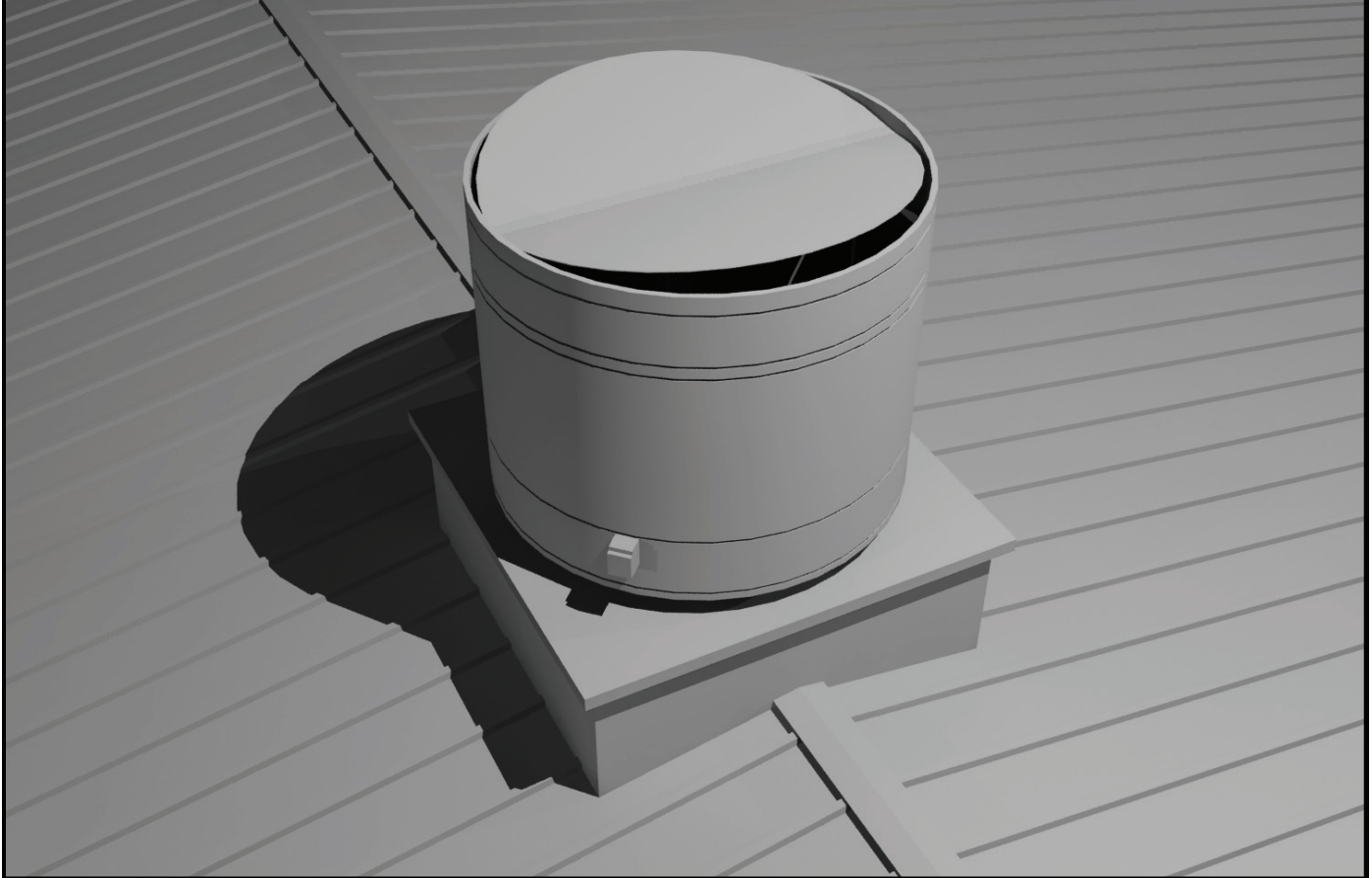

SPECIFICATIONS

- **CONSTRUCTION:**

- Roof Ventilator assembly incorporates an angle frame design along with an all-welded curb cap fabricated from heavy gauge Galvanized steel
- Dampers constructed of durable fiberglass
- A finish coat of epoxy on exposed steel surfaces provides additional protection when specified.

- **DESIGN:**

- Upblast power roof fans are of the vertical discharge design in which air velocity seals the opening against rain and snow while the unit is in operation. When the fan is off, counterbalanced dampers close by gravity to provide a weather-resistant closure.
- Designed for long life and low maintenance.
- All fans AMCA rated for air performance.

- **FEATURES:**

- Direct-drive or Belt-drive
- Blade diameters from 24" to 84"
- Motor and drive either recessed in the curb or mounted outside the airstream when specified

- **MOTORS:**

- 1/4 to 20 horsepower
- Single and 3 phase Motors
- Open Drip-Proof (ODP), Totally Enclosed Fan Cooled (TEFC), Totally Enclosed Ball Bearing (TEBB) or Explosion-Proof as required

- **ACCESSORIES:**

- Roof Curb (Conventional or Metal Building)
- Disconnect Switch

CALL FOR CURRENT PRICING



DESIGN COMPONENTS, INC. Serving the Metal Building Industry since 1978

115 Walter Way	Fayetteville, GA 30214	email: sales@designcomponents.com
PH (800) 868-9910	FX (770) 460-7872	website: www.designcomponents.com

OTHER FANS AVAILABLE

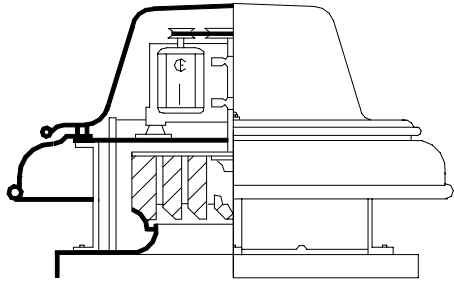

CENTRIFUGAL ROOF EXHAUST FAN

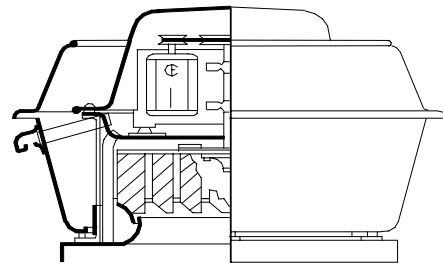

UPBLAST ROOF EXHAUST FAN

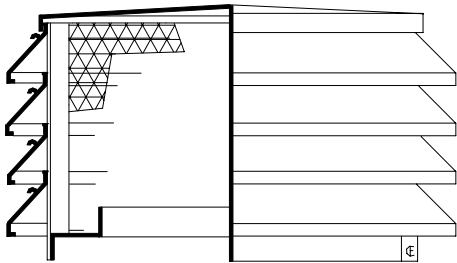

LOUVERED PENTHOUSE

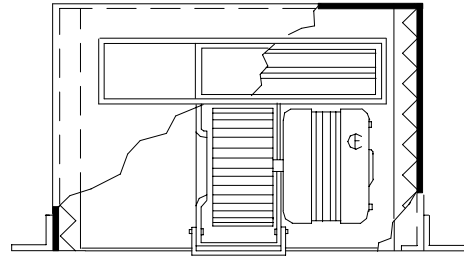

CEILING MOUNTED CABINET FAN

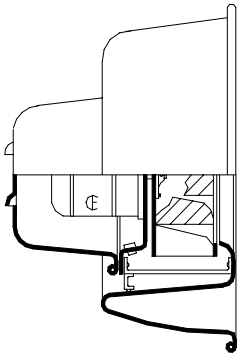

WALL MOUNTED EXHAUST FAN

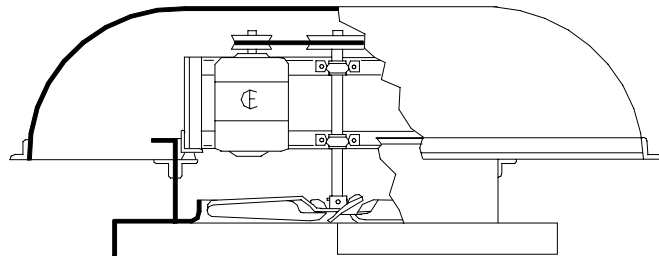

AXIAL FLOW ROOF EXHAUST FAN

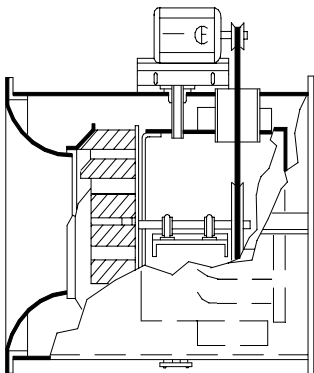

IN-LINE EXHAUST FAN

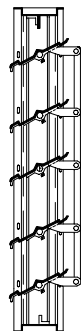

DAMPER

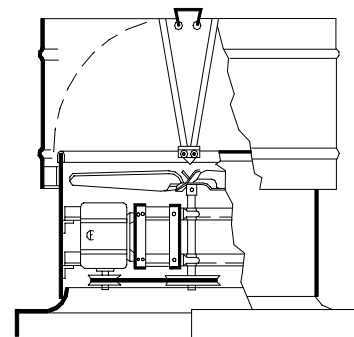

VERTICAL DISCHARGE FAN



DESIGN COMPONENTS, INC. Serving The Metal Building Industry Since 1978

115 Walter Way	Fayetteville, GA 30214	email: sales@designcomponents.com
PH (800) 868-9910	FX (770) 460-7872	website: www.designcomponents.com