

# WALL FANS



## SPECIFICATIONS

- **CONSTRUCTION:**

- Wall Fans feature heavy gauge Galvanized steel frame with motor and drive mounted in a pre-assembled wall housing for easy installation in existing wall opening.
- Wall Shutters feature extruded aluminum mill finish blades and durable powder coated steel frame that mounts to fan housing.

- **DESIGN:**

- Fan with exclusive "X-Wing" automatic belt tensioning system incorporating motor and bearing mounts extends motor life and eliminates the need for belt adjusting. Furnished standard on all 36" & 48" wall fans with up to 1-1/2 hp motors.
- Shutter automatically opens when fan is switched on and closes when air flow stops.

- **STANDARD STOCK SIZES:**

- 36" Diameter Propeller (40" x 40" Frame)  
1/2hp, 115/1/60 Belt-Drive Motor - 10,400cfm
- 48" Diameter Propeller (52" x 52" Frame)  
3/4hp, 115/1/60 Belt-Drive Motor - 18,900cfm

- **MOTOR OPTIONS:**

- Single or 3 phase motors available from 1/2 to 5 hp
- Totally enclosed and explosion-proof motors available when specified.

- **ACCESSORIES:**

- Fan Guard (required if fan is mounted within 7' AFF)
- Motorized Shutter (for supply fan only)
- Weather Hood (shipped knocked down)

OTHER SIZES AND OPTIONS AVAILABLE

**CALL FOR CURRENT PRICING**



**DESIGN COMPONENTS, INC.** Serving the Metal Building Industry since 1978

115 Walter Way	Fayetteville, GA 30214	email: sales@designcomponents.com
PH (800) 868-9910	FX (770) 460-7872	website: www.designcomponents.com

# OTHER FANS AVAILABLE

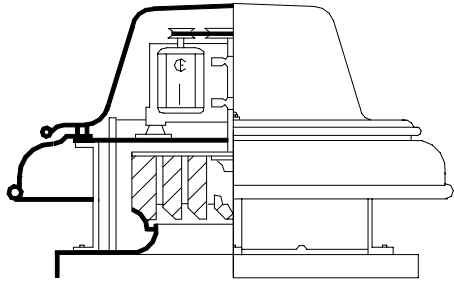

**CENTRIFUGAL ROOF EXHAUST FAN**

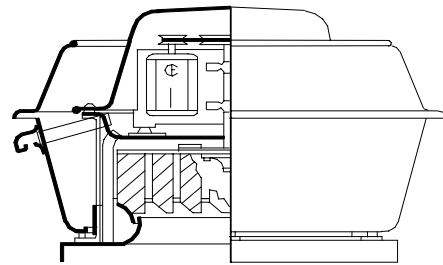

**UPBLAST ROOF EXHAUST FAN**

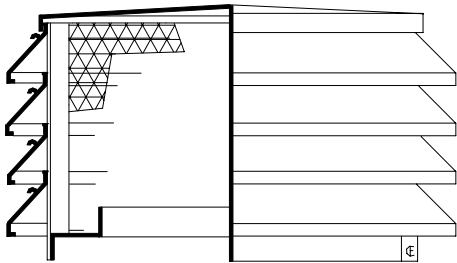

**LOUVERED PENTHOUSE**

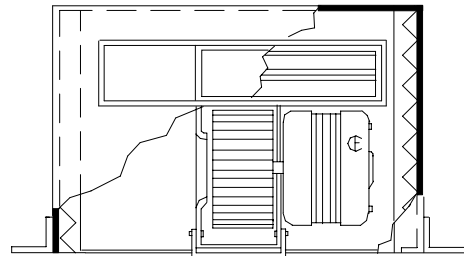

**CEILING MOUNTED CABINET FAN**

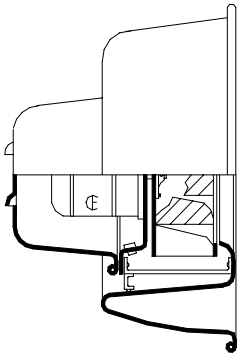

**WALL MOUNTED EXHAUST FAN**

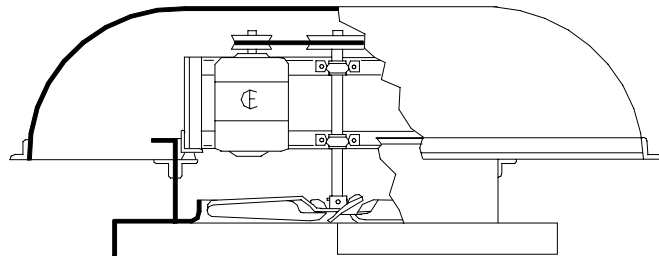

**AXIAL FLOW ROOF EXHAUST FAN**

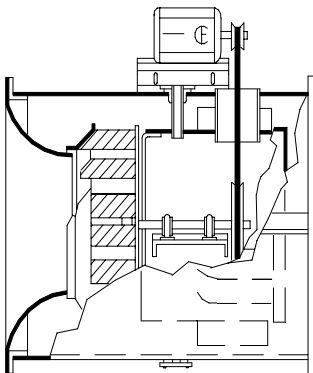

**IN-LINE EXHAUST FAN**

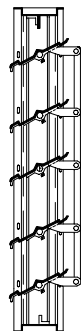

**DAMPER**

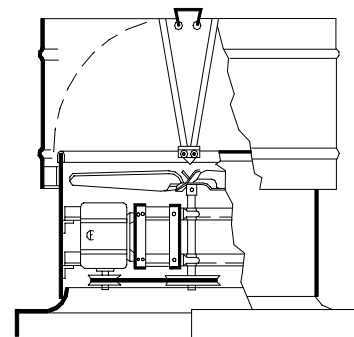

**VERTICAL DISCHARGE FAN**



**DESIGN COMPONENTS, INC.** Serving The Metal Building Industry Since 1978

115 Walter Way	Fayetteville, GA 30214	email: <a href="mailto:sales@designcomponents.com">sales@designcomponents.com</a>
PH (800) 868-9910	FX (770) 460-7872	website: <a href="http://www.designcomponents.com">www.designcomponents.com</a>